

# UIE48T24050 DC-DC CONVERTER

## 18-75V<sub>DC</sub> Input; 5V<sub>DC</sub>, 24A, 120W Output

### FEATURES

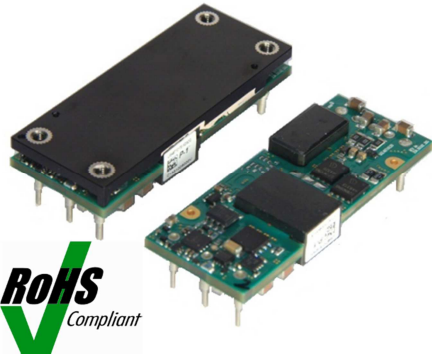

- Industry-standard eighth-brick pin-out
- Ultra wide input voltage range
- Delivers 120W at 91% efficiency
- Paste In Hole (PIH) compatible
- Withstands 100V input transient for 100ms
- Fixed-frequency operation
- On-board input differential LC-filter
- Start-up into pre-biased load
- No minimum load required
- Minimum of 2,250V<sub>DC</sub> I/O isolation
- Fully protected (OTP, OCP, OVP, UVLO)
- Positive or negative logic ON/OFF option
- Low height of 0.44" (11.18mm)
- Weight: 32g w/o baseplate / heat spreader, 40g w/ baseplate / heat spreader
- High reliability: MTBF = 14.3 million hours, calculated per Telcordia SR-332, Method I Case 1
- Approved to the following Safety Standards: UL/CSA60950-1 2<sup>nd</sup> Ed, EN60950-1 2<sup>nd</sup> Ed, and IEC60950-1 2<sup>nd</sup> Ed
- Designed to meet Class B conducted emissions per FCC and EN55022 when used with external filter
- All materials meet UL94, V-0 flammability rating

### APPLICATIONS

- Intermediate Bus Architectures
- Data communications/processing
- LAN/WAN
- Servers, storage, instrumentation, embedded equipment

### BENEFITS

- High efficiency – no heat sink required<sup>1</sup>
- Industry-standard eighth brick footprint: 0.896" x 2.30" (2.06 in<sup>2</sup>), 38% smaller than conventional quarter-bricks
- PIH Compatibility on both the open frame and baseplate models simplifying the manufacturing process by eliminating the need for wave soldering.

### DESCRIPTION

The high performance 24A **UIE48T24050** DC-DC converter provides a high efficiency single output, in a 1/8<sup>th</sup> brick package that is only 62% the size of the industry-standard quarter-brick. Specifically designed for operation in systems that have limited airflow and increased ambient temperatures, the UIE48T24050 converter utilizes the same pinout and Input/Output functionality of the industry-standard quarter-bricks. In addition, a baseplate / heat spreader feature is available (-xDxBx suffix) that provides an effective thermal interface for coldplate and heat sinking options.

The UIE48T24050 converter thermal performance is accomplished through the use advanced circuits, packaging, and processing techniques to achieve ultra-high efficiency, excellent thermal management, and a low-body profile.

Operating from a wide-range 18-75V input, the UIE48T24050 converter utilizes digital control and provides a fully regulated 5V output voltage. Employing a standard power pinout, the UIE48T24050 converter is an ideal drop-in replacement for existing high current quarter-brick designs. Inclusion of this converter in a new design can result in significant board space and cost savings. The designer can expect reliability improvement over other available converters because of the UIE48T24050's optimized thermal efficiency.

<sup>1</sup> Baseplate / Heat Spreader option (suffix '-xDxBx') facilitates heatsink mounting to further enhance the unit's thermal capability.

## 1 ELECTRICAL SPECIFICATIONS

Conditions:  $T_A = 25\text{ }^\circ\text{C}$ , Airflow = 300 LFM (1.5 m/s),  $V_{in} = 48\text{ VDC}$ ,  $C_{in} = 100\text{ }\mu\text{F}$ , unless otherwise specified.

PARAMETER	NOTES	MIN	TYP	MAX	UNITS
<b>Absolute Maximum Ratings</b>					
Input Voltage	Continuous	-0.3		80	VDC
	Transient (100ms)			100	VDC
Operating Temperature (See Derating Curves)	Ambient ( $T_A$ )	-40		85	$^\circ\text{C}$
	<sup>2</sup> Component ( $T_C$ )	-40		125	$^\circ\text{C}$
Storage Temperature		-55		125	$^\circ\text{C}$
<b>Isolation Characteristics</b>					
Isolation Voltage					
Input to Output		2,250			VDC
Input to Baseplate		1,500			VDC
Output to Baseplate		1,500			VDC
Isolation Resistance		10			$\text{M}\Omega$
Isolation Capacitance			750		$\mu\text{F}$
<b>Feature Characteristics</b>					
Switching Frequency			250		kHz
Output Overvoltage Protection (Non-latching)		115	120	130	%
Over Temperature Shutdown (Non-latching)	<sup>2</sup> Component ( $T_C$ )		130		$^\circ\text{C}$
Auto-Restart Period	Applies to all protection features		500		ms
Turn-On Time from $V_{in}$	Time from UVLO to $V_o = 90\%V_{OUT(NOM)}$ Resistive load		100	130	ms
Turn-On Time from ON/OFF Control	Time from ON to $V_o = 90\%V_{OUT(NOM)}$ Resistive load		100	130	ms
Turn-On Time from $V_{in}$ (w/ $C_o$ max.)	Time from UVLO to $V_o = 90\%V_{OUT(NOM)}$ Resistive load, $C_{EXT} = 4,700\mu\text{F}$ load		100	130	ms
Turn-On Time from ON/OFF Control (w/ $C_o$ max.)	Time from ON to $V_o = 90\%V_{OUT(NOM)}$ Resistive load, $C_{EXT} = 4,700\mu\text{F}$ load		100	130	ms
ON/OFF Control (Positive Logic)	Converter Off (logic low)	-15		0.8	VDC
	Converter On (logic high)	2.4		15	VDC
ON/OFF Control (Negative Logic)	Converter Off (logic low)	2.4		15	VDC
	Converter On (logic high)	-15		0.8	VDC
<b>Input Characteristics</b>					
Operating Input Voltage Range		18	48	75	VDC
Input Undervoltage Lockout					
Turn-on Threshold		16.8	17.2	17.8	VDC
Turn-off Threshold		14.9	15.5	16.1	VDC
Lockout Hysteresis Voltage		0.5	1.7	2.5	VDC
Maximum Input Current	$P_o = 120\text{ W}$ @ 18VDC In			7.6	ADC
Input Standby Current	$V_{in} = 48\text{ V}$ , converter disabled		3	5	mA
Input No Load Current (No load on the output)	$V_{in} = 48\text{ V}$ , converter enabled	40	70	100	mA
Input Reflected-Ripple Current, $i_c$	$V_{in} = 48\text{ V}$ , 20 MHz bandwidth, $P_o = 120\text{ W}$ (Figs. 14, 15, 16)		1500	1800	$\text{mA}_{PK-PK}$
			500	600	$\text{mA}_{RMS}$
Input Reflected-Ripple Current, $i_s$			60	75	$\text{mA}_{PK-PK}$
			20	30	$\text{mA}_{RMS}$
Input Voltage Ripple Rejection	120 Hz		45		dB

<sup>2</sup> Reference Figure G for component  $T_C$  locations.

## 1 ELECTRICAL SPECIFICATIONS (CONTINUED)

Conditions:  $T_A = 25\text{ °C}$ , Airflow = 300 LFM (1.5 m/s),  $V_{in} = 48\text{ VDC}$ ,  $C_{in} = 100\text{ }\mu\text{F}$ , unless otherwise specified.

PARAMETER	NOTES	MIN	TYP	MAX	UNITS
<b>Output Characteristics</b>					
Output Voltage Setpoint	$V_{IN}=48\text{V}$ , $I_{OUT}=0\text{A}$ , $T_A=25\text{°C}$	4.90	5.00	5.10	VDC
Output Voltage Trim Range <sup>3</sup>	Industry-std. equations	-20		+10	%
Remote Sense Compensation <sup>4</sup>	Percent of $V_{OUT(NOM)}$			+10	%
Output Regulation					
Over Line	$I_{OUT}=24\text{A}$ , $T_A=25\text{°C}$		±24	±48	mV
Over Load	$V_{IN}=48\text{V}$ , $T_A=25\text{°C}$		±15	±30	mV
Output Voltage Range	Over line, load and temperature	4.85		5.15	VDC
Output Ripple and Noise – 20 MHz bandwidth	$I_{OUT}=24\text{A}$ , $C_{EXT} = 10\text{ }\mu\text{F}$ tantalum + $1\text{ }\mu\text{F}$ ceramic		50	100	mV <sub>PK-PK</sub>
			25	50	mV <sub>RMS</sub>
Admissible External Load Capacitance <sup>3</sup>	$I_{OUT}=24\text{A}$ (resistive) $C_{EXT}$ ESR	0		4,700	$\mu\text{F}$
		1			$\text{m}\Omega$
Output Current Range		0		24	ADC
Current Limit Inception	Non-latching	27	29	31	ADC
RMS Short-Circuit Current	Non-latching Short = $10\text{ m}\Omega$		5	10	A <sub>RMS</sub>
<b>Dynamic Response</b>					
Load Change 50%-75%-50% of $I_{OUT}$ Max ( $di/dt = 0.1\text{ A}/\mu\text{s}$ )	$C_{EXT} = 10\mu\text{F}$ tantalum + $1\mu\text{F}$ ceramic		200	400	mV
Settling Time to 2% of $V_{OUT}$			200		$\mu\text{s}$
<b>Efficiency</b>					
	$48V_{IN}$ , $T_A=25\text{°C}$ , 300LFM		91		%
@ 100% Load					
@ 60% Load			91.5		%

## 2 ENVIRONMENT AND MECHANICAL SPECIFICATIONS

PARAMETER	NOTES	MIN	TYP	MAX	UNITS
<b>Environmental</b>					
Operating Humidity	Non-condensing			95	%
Storage Humidity	Non-condensing			95	%
<b>Mechanical</b>					
Weight	Without baseplate / heat spreader		32		g
	With baseplate / heat spreader		40		g
Vibration	GR-63-CORE, Sect. 5.4.2	1			g
Shocks	Half Sinewave, 3-axis	50			g
<b>Reliability</b>					
MTBF	Telcordia SR-332, Method I Case 1 50% electrical stress, 40°C components		14.3		MHrs
<b>EMI and Regulatory Compliance</b>					
Conducted Emissions	CISPR 22 B with external EMI filter network				

<sup>3</sup> Input voltage should >22V

<sup>4</sup> See "Input Output Impedance", Page 4.

### 3 OPERATIONS

#### 3.1 INPUT AND OUTPUT IMPEDANCE

These power converters have been designed to be stable with no external capacitors when used in low inductance input and output circuits.

However, in some applications, the inductance associated with the distribution from the power source to the input of the converter can affect the stability of the converter. A 100  $\mu\text{F}$  electrolytic capacitor with adequate ESR based on input impedance is recommended to ensure stability of the converter.

In many end applications, a high capacitance value is applied to the converter's output via distributed capacitors. The power converter will exhibit stable operation with external load capacitance up to 4,700  $\mu\text{F}$ .

#### 3.2 ON/OFF (PIN 2)

The ON/OFF pin is used to turn the power converter on or off remotely via a system signal. There are two remote control options available, positive and negative logic, with both referenced to  $V_{in(-)}$ . A typical connection is shown in Figure A.

The positive logic version turns on when the ON/OFF pin is at a logic high or left open and turns off when it is at a logic low. See the Electrical Specifications for logic high/low definitions.

Fig. A: Typ. Circuit configuration for ON/OFF function.

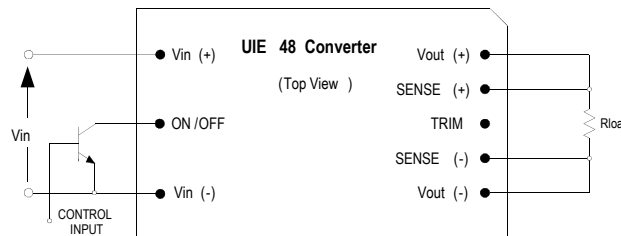

The negative logic version turns on when the ON/OFF pin is at a logic low and turns off when the pin is at logic high. To enable automatic power up of the converter without the need of an external control signal the ON/OFF pin can be hard wired directly to  $V_{in(-)}$  for N and left open for P version.

A properly de-bounced mechanical switch, open-collector transistor, or FET can be used to drive the input of the ON/OFF pin. The device must be capable of sinking up to 0.2 mA at a low level voltage of  $\leq 0.8\text{ V}$ . An external voltage source ( $\pm 15\text{ V}$  maximum) may be connected directly to the ON/OFF input, in which case it must be capable of sourcing or sinking up to 1 mA depending on the signal polarity. If optocoupler is used to control the on/off, then the ON/OFF pin should be tied to a 3V3 rail via 3.3kohm resistor to prevent optocoupler leakage from affecting the on/off function. See the Startup Information section for system timing waveforms associated with use of the ON/OFF pin.

#### 3.3 SENSE (PINS 5 AND 7)

The remote sense feature of the converter compensates for voltage drops occurring between the output pins of the converter and the load. The SENSE(-) (Pin 5) and SENSE(+) (Pin 7) pins should be connected at the load or at the point where regulation is required (see Fig. B).

Fig. B: Remote sense circuit configuration.

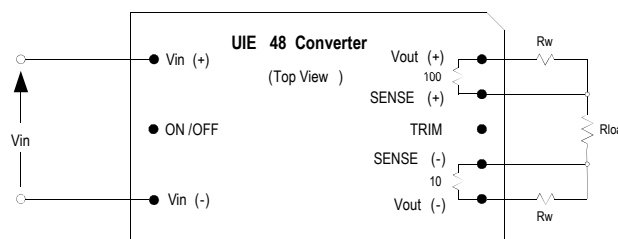

**CAUTION**

If remote sensing is not utilized, the SENSE (-) pin must be connected to the Vout (-) pin (Pin 4), and the SENSE (+) pin must be connected to the Vout (+) pin (Pin 8) to ensure the converter will regulate at the specified output voltage. If these connections are not made, the converter will deliver an output voltage that is higher than the specified data sheet value.

Because the sense leads carry minimal current, large traces on the end-user board are not required. However, sense traces should be run side by side and located close to a ground plane to minimize system noise and ensure optimum performance.

The converter's output overvoltage protection (OVP) senses the voltage across Vout (+) and Vout (-), and not across the sense lines, so the resistance (and resulting voltage drop) between the output pins of the converter and the load should be minimized to prevent unwanted triggering of the OVP.

When utilizing the remote sense feature, care must be taken not to exceed the maximum allowable output power capability of the converter, which is equal to the product of the nominal output voltage and the allowable output current for the given conditions.

When using remote sense, the output voltage at the converter can be increased by as much as 10% above the nominal rating in order to maintain the required voltage across the load. Therefore, the designer must, if necessary, decrease the maximum current (originally obtained from the derating curves) by the same percentage to ensure the converter's actual output power remains at or below the maximum allowable output power.

**3.4 OUTPUT VOLTAGE ADJUST /TRIM (PIN 6)**

The output voltage can be adjusted up 10% or down 20%, relative to the rated output voltage by the addition of an externally connected resistor.

The TRIM pin should be left open if trimming is not being used. To minimize noise pickup, a 0.1 μF capacitor is connected internally between the TRIM and SENSE (-) pins.

To increase the output voltage, refer to Fig. C. A trim resistor, R<sub>T-INCR</sub>, should be connected between the TRIM (Pin 6) and SENSE (+) (Pin 7), with a value of:

$$R_{T-INCR} = \frac{5.11(100 + \Delta)V_{O-NOM} - 626}{1.225\Delta} - 10.22 \text{ [k}\Omega\text{]}$$

where,

R<sub>T-INCR</sub> = Required value of trim-up resistor kΩ

V<sub>O-NOM</sub> = Nominal value of output voltage [V]

$$\Delta = \left| \frac{(V_{O-REQ} - V_{O-NOM})}{V_{O-NOM}} \right| \times 100 \quad [\%]$$

V<sub>O-REQ</sub> = Desired (trimmed) output voltage [V].

When trimming up, care must be taken not to exceed the converter's maximum allowable output power. See the previous section for a complete discussion of this requirement.

Fig. C: Configuration for increasing output voltage.

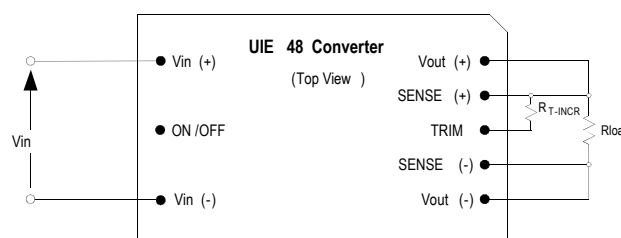

To decrease the output voltage (Fig. D), a trim resistor,  $R_{T-DECR}$ , should be connected between the TRIM (Pin 6) and SENSE(-) (Pin 5), with a value of:

$$R_{T-DECR} = \frac{511}{|\Delta|} - 10.22 \quad [\text{k}\Omega]$$

where,

$R_{T-DECR}$  = Required value of trim-down resistor [k $\Omega$ ] and  $\Delta$  is defined above.

**Note:** The above equations for calculation of trim resistor values match those typically used in conventional industry-standard quarter-bricks and one-eighth bricks.

Fig. D: Configuration for decreasing output voltage.

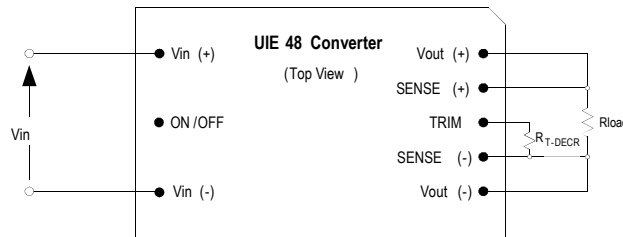

Trimming/sensing beyond 110% of the rated output voltage is not an acceptable design practice, as this condition could cause unwanted triggering of the output overvoltage protection (OVP) circuit. The designer should ensure that the difference between the voltages across the converter's output pins and its sense pins does not exceed 10% of  $V_{OUT(NOM)}$ , or:

$$[V_{OUT(+)} - V_{OUT(-)}] - [V_{SENSE(+)} - V_{SENSE(-)}] \leq V_{O-NOM} \times 10\% \quad [V]$$

This equation is applicable for any condition of output sensing and/or output trim.

## 4 PROTECTION FEATURES

### 4.1 INPUT UNDERVOLTAGE LOCKOUT (UVLO)

Input undervoltage lockout is standard with this converter. The converter will shut down when the input voltage drops below a pre-determined voltage.

The input voltage must be typically 17.2V for the converter to turn on. Once the converter has been turned on, it will shut off when the input voltage drops typically below 15.5V. This feature is beneficial in preventing deep discharging of batteries used in telecom applications.

### 4.2 OUTPUT OVERCURRENT PROTECTION (OCP)

The converter is protected against overcurrent or short circuit conditions. Upon sensing an overcurrent condition, the converter will shut down after entering the constant current mode of operation, regardless of the value of the output voltage.

Once the converter has shut down, it will enter hiccup mode with attempt to restart every 500 ms until the overload or short circuit conditions are removed.

### 4.3 OUTPUT OVERVOLTAGE PROTECTION (OVP)

The converter will shut down if the output voltage across  $V_{out}(+)$  and  $V_{out}(-)$  exceeds the threshold of the OVP circuitry. Once the converter has shut down, it will attempt to restart every 500 ms until the OVP condition is removed.

### 4.4 OVERTEMPERATURE PROTECTION (OTP)

The converter will shut down under an overtemperature condition to protect itself from overheating caused by operation outside the thermal derating curves, or operation in abnormal conditions. The converter will automatically restart after it has cooled to a safe operating temperature.

#### 4.5 SAFETY REQUIREMENTS

The converters are safety approved to UL/CSA60950-1 2<sup>nd</sup> Ed, EN60950-1 2<sup>nd</sup> Ed and IEC60950-1 2<sup>nd</sup> Ed. Basic Insulation is provided between input and output.

The converters have no internal fuse. To comply with safety agencies requirements, an input line fuse must be used external to the converter. The fuse must not be placed in the grounded input line.

The UIE48 converter is UL approved for a fuse rating of 12.5 Amps.

#### 4.6 ELECTROMAGNETIC COMPATIBILITY (EMC)

EMC requirements must be met at the end-product system level, as no specific standards dedicated to EMC characteristics of board mounted component dc-dc converters exist. However, Power-One tests its converters to several system level standards, primary of which is the more stringent EN55022, Information technology equipment - Radio disturbance characteristics - Limits and methods of measurement.

An effective internal LC differential filter significantly reduces input reflected ripple current, and improves EMC.

With the addition of an external filter, the UIE48T24050 converter will pass the requirements of Class B conducted emissions per EN55022 and FCC requirements. Refer to Figures 18 – 19 for typical performance with external filter.

#### 4.7 STARTUP INFORMATION (USING NEGATIVE ON/OFF)

##### Scenario #1: Initial Startup From Bulk Supply

ON/OFF function enabled, converter started via application of  $V_{IN}$ . See Figure E.

Time	Comments
$t_0$	ON/OFF pin is ON; system front-end power is toggled on, $V_{IN}$ to converter begins to rise.
$t_1$	$V_{IN}$ crosses undervoltage Lockout protection circuit threshold; converter enabled.
$t_2$	Converter begins to respond to turn-on command (converter turn-on delay).
$t_3$	Converter $V_{OUT}$ reaches 100% of nominal value.

For this example, the total converter startup time ( $t_3 - t_1$ ) is typically 100 ms.

Fig. E: Startup scenario #1.

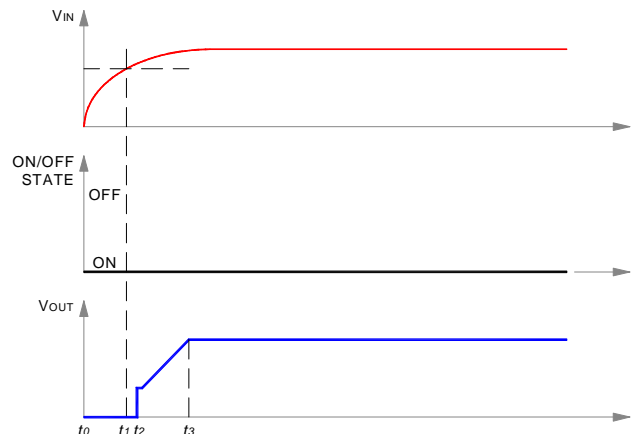

##### Scenario #2: Initial Startup Using ON/OFF Pin

With  $V_{IN}$  previously powered, converter started via ON/OFF pin. See Figure F.

Time	Comments
$t_0$	$V_{IN}$ at nominal value.
$t_1$	Arbitrary time when ON/OFF pin is enabled (converter enabled).
$t_2$	End of converter turn-on delay.
$t_3$	Converter $V_{OUT}$ reaches 100% of nominal value.

For this example, the total converter startup time ( $t_3 - t_1$ ) is typically 100 ms.

Fig. F: Startup scenario #2.

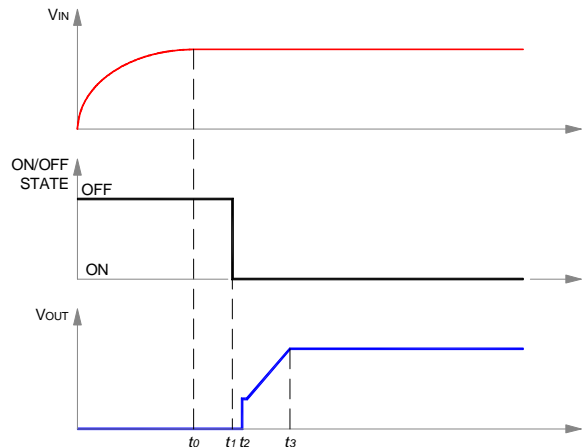

## 5 CHARACTERIZATION

### 5.1 GENERAL INFORMATION

The converter has been characterized for many operational aspects, to include thermal derating (maximum load current as a function of ambient temperature and airflow), efficiency, startup and shutdown parameters, output ripple and noise, transient response to load step-change, overcurrent, and short circuit.

The following pages contain specific plots or waveforms associated with the converter. Additional comments for specific data are provided below.

### 5.2 TEST CONDITIONS

All data presented were taken with the converter soldered to a test board, specifically a 0.060" thick printed wiring board (PWB) with four layers. The top and bottom layers were not metallized. The two inner layers, comprised of two-ounce copper, were used to provide traces for connectivity to the converter.

The lack of metallization on the outer layers as well as the limited thermal connection ensured that heat transfer from the converter to the PWB was minimized. This provides a worst-case but consistent scenario for thermal derating purposes.

All measurements requiring airflow were made in the vertical and horizontal wind tunnel using Infrared (IR) thermography and thermocouples for thermometry.

Ensuring components on the converter do not exceed their ratings is important to maintaining high reliability. If one anticipates operating the converter at or close to the maximum loads specified in the derating curves, it is prudent to check actual operating temperatures in the application. Thermographic imaging is preferable; if this capability is not available, then thermocouples may be used. The use of AWG #40 gauge thermocouples is recommended to ensure measurement accuracy. Careful routing of the thermocouple leads will further minimize measurement error. Refer to Figure G for the optimum measuring thermocouple location.

### 5.3 THERMAL DERATING – AIR COOLED

Load current vs. ambient temperature and airflow rates are given in Figures 1 for converter w/o baseplate / heat spreader, and in Figures 5 for converter with baseplate / heat spreader equipped with a .45" finned heat sink. Ambient temperature was varied between 25°C and 85°C, with airflow rates from 30 to 500LFM (0.15 to 2.5m/s) and with  $V_{IN}=48V$ .

Load current vs. ambient temperature and airflow rates are given in Figure 3 for a converter w/o baseplate / heat spreader. Ambient temperature was varied between 25°C and 85°C, with airflow rates from 30 to 500LFM (0.15 to 2.5m/s) and with  $V_{IN}=24V$ .

Note that the use of baseplate / heat spreader alone without heatsink or attachment to cold plate provides lower power rating than open frame due to the restriction of airflow across the module.



For each set of conditions, the maximum load current was defined as the lowest of:

- (i) The output current at which any FET junction temperature does not exceed a maximum temperature of 125°C as indicated by the thermal measurement.
- (ii) The output current at which the temperature at the thermocouple locations  $T_{c1}$  and  $T_{c2}$  do not exceed 133°C (Figure G).
- (iii) The nominal rating of the converter (24A/120W).

Fig. G: Locations of the thermocouples for thermal testing.

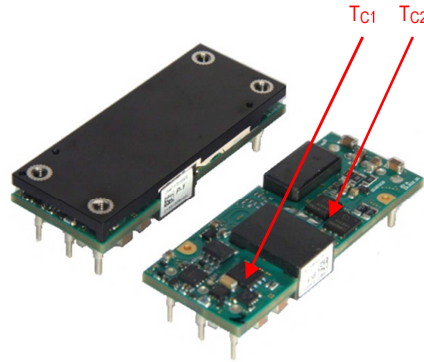

#### 5.4 EFFICIENCY

Figure 7 shows the efficiency vs. load current plot for ambient temperature ( $T_A$ ) of 25°C and for converter w/o baseplate / heat spreader, air flowing from pin 3 to pin 1 at a rate of 300LFM (1.5m/s) with vertically mounting and input voltages of 18V, 24V, 36V, 48V, 60V and 75V.

#### 5.5 POWER DISSIPATION

Figure 8 shows the power dissipation vs. load current plot for ambient temperature ( $T_A$ ) of 25°C and for converter w/o baseplate / heat spreader, air flowing from pin 3 to pin 1 at a rate of 300 LFM (1.5 m/s) with vertically mounting and input voltages of 18V, 24V, 36V, 48V, 60V and 75V.

#### 5.6 STARTUP

Output voltage waveforms, during the turn-on transient using the ON/OFF pin for full rated load currents (resistive load) are shown with and without external load capacitance in Figure 9 and 10, respectively.

#### 5.7 RIPPLE AND NOISE

Figure 13 shows the output voltage ripple waveform, measured at full rated load current with a 10 $\mu$ F tantalum and a 1 $\mu$ F ceramic capacitor across the output. Note that all output voltage waveforms are measured across the 1 $\mu$ F ceramic capacitor.

The input reflected-ripple current waveforms are obtained using the test setup shown in Figure 14.

The corresponding waveforms are shown in Figure 15 and Figure 16.

Fig. 1: Available load current vs. ambient air temperature and airflow rates for UIE48T24050 converter w/o baseplate mounted vertically with air flowing from pin 3 to pin 1, MOSFET temperature  $\leq 125^{\circ}\text{C}$ ,  $V_{in}=48\text{V}$

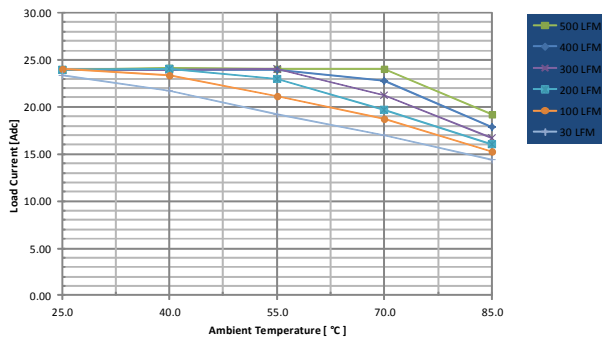

Fig. 2: Power derating vs. ambient air temperature and airflow rates for UIE48T24050 converter w/o baseplate mounted vertically with air flowing from pin 3 to pin 1, MOSFET temperature  $\leq 125^{\circ}\text{C}$ ,  $V_{in}=48\text{V}$

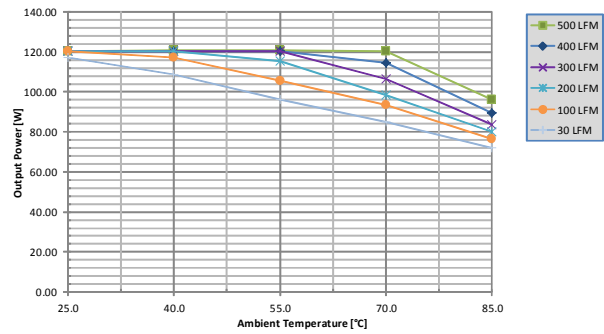

Fig. 3: Available load current vs. ambient air temperature and airflow rates for UIE48T24050 converter w/o baseplate mounted vertically with air flowing from pin 3 to pin 1, MOSFET temperature  $\leq 125^{\circ}\text{C}$ ,  $V_{in}=24\text{V}$

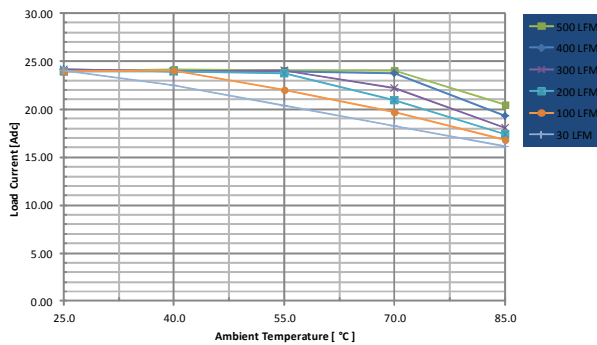

Fig. 4: Power derating vs. ambient air temperature and airflow rates for UIE48T24050 converter w/o baseplate mounted vertically with air flowing from pin 3 to pin 1, MOSFET temperature  $\leq 125^{\circ}\text{C}$ ,  $V_{in}=24\text{V}$

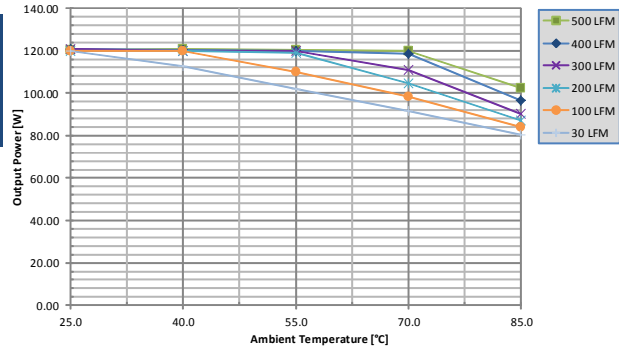

Fig. 5: Available load current vs. ambient air temperature and airflow rates for UIE48T24050 converter with baseplate equipped with .45" finned heatsink mounted vertically with air flowing from pin 3 to pin 1, MOSFET temperature  $\leq 125^{\circ}\text{C}$ ,  $V_{in}=48\text{V}$

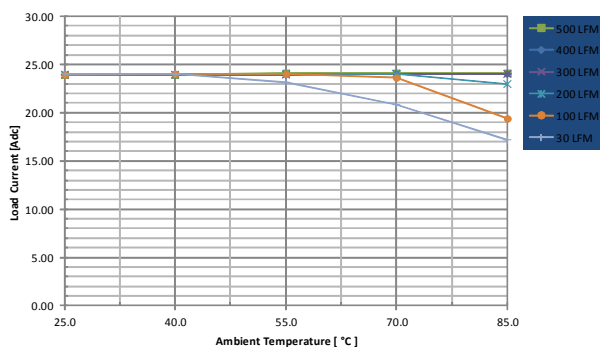

Fig. 6: Power derating vs. ambient air temperature and airflow rates for UIE48T24050 converter with baseplate equipped with .45" finned heatsink mounted vertically with air flowing from pin 3 to pin 1, MOSFET temperature  $\leq 125^{\circ}\text{C}$ ,  $V_{in}=48\text{V}$

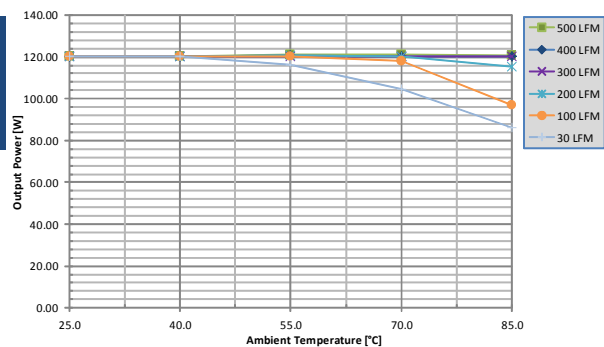

Fig. 7: Efficiency vs. load current and input voltage for UIE48T24050 converter w/o baseplate mounted vertically with air flowing from pin 3 to pin 1 at a rate of 300 LFM (1.5 m/s) and  $T_a = 25^\circ\text{C}$ .

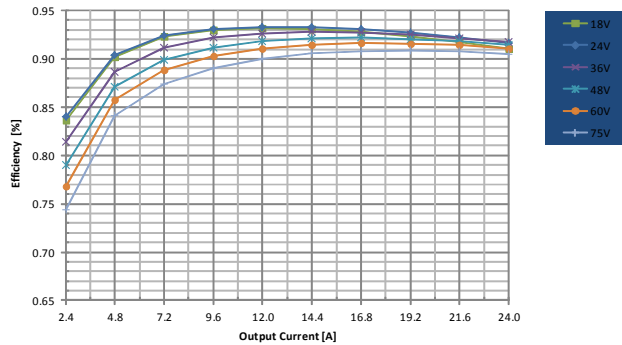

Fig. 8: Power dissipation vs. load current and input voltage for UIE48T24050 converter w/o baseplate mounted vertically with air flowing from pin 3 to pin 1 at a rate of 300 LFM (1.5 m/s) and  $T_a = 25^\circ\text{C}$ .

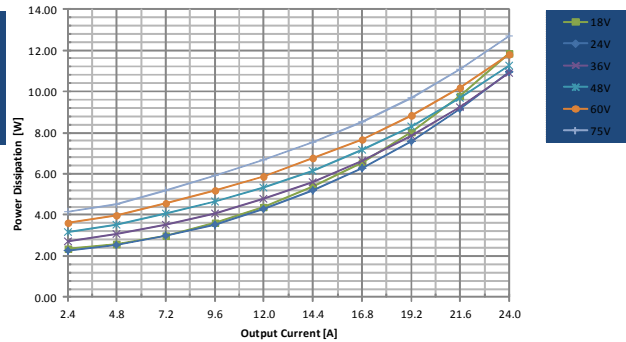

Fig. 9: Turn-on transient at full rated load current (resistive) with  $C_{out}$  10  $\mu\text{F}$  tantalum + 1  $\mu\text{F}$  ceramic at  $V_{in} = 48\text{ V}$ , triggered via ON/OFF pin. Top trace: ON/OFF signal (5 V/div.). Bottom trace: output voltage (2 V/div.). Time scale: 20 ms/div.

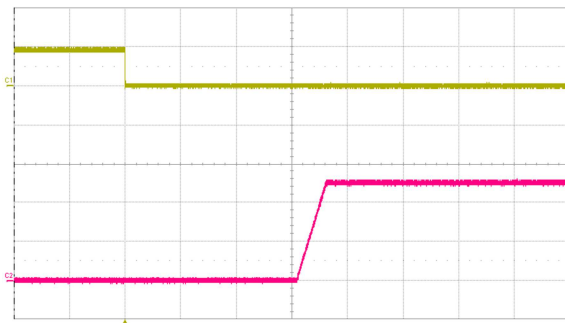

Fig. 10: Turn-on transient at full rated load current (resistive) plus 4,700  $\mu\text{F}$  at  $V_{in} = 48\text{ V}$ , triggered via ON/OFF pin. Top trace: ON/OFF signal (5 V/div.). Bottom trace: output voltage (2 V/div.). Time scale: 20 ms/div.

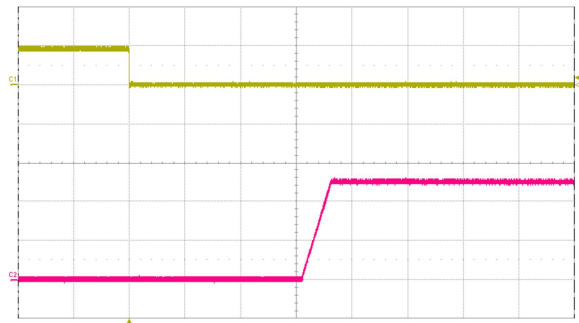

Fig. 11: Output voltage response to load current step change (12A – 18A – 12A) at  $V_{in} = 48\text{ V}$ . Top trace: output voltage (200 mV/div.). Bottom trace: load current (10 A/div.). Current slew rate: 0.1 A/ $\mu\text{s}$ .  $C_o = 1\ \mu\text{F}$  ceramic + 10  $\mu\text{F}$  tantalum. Time scale: 200  $\mu\text{s}$ /div.

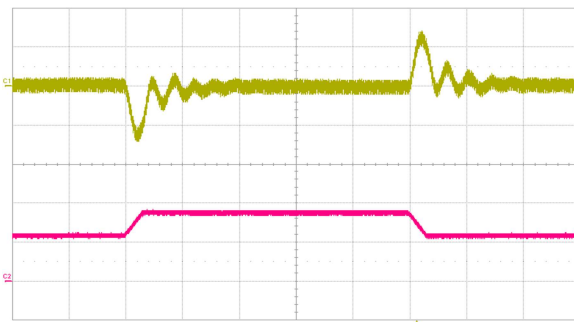

Fig. 12: Output voltage response to load current step change (12A – 18A – 12A) at  $V_{in} = 48\text{ V}$ . Top trace: output voltage (200 mV/div.). Bottom trace: load current (10 A/div.). Current slew rate: 1 A/ $\mu\text{s}$ .  $C_o = 1\ \mu\text{F}$  ceramic + 4,700  $\mu\text{F}$  + 10  $\mu\text{F}$  tantalum. Time scale: 200  $\mu\text{s}$ /div.

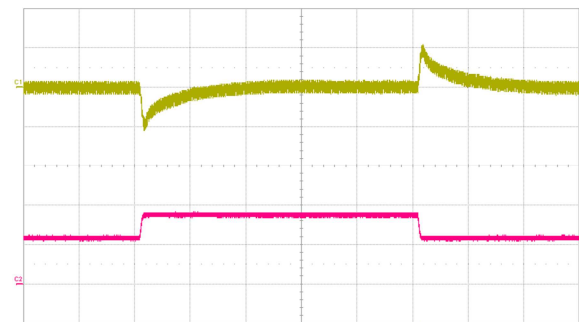

Fig. 13: Output voltage ripple (50 mV/div.) at full rated load currents, current into a resistive load with  $C_o = 10 \mu\text{F}$  tantalum +  $1 \mu\text{F}$  ceramic and  $V_{in} = 48 \text{ V}$ . Time scale:  $2 \mu\text{s}/\text{div}$ .

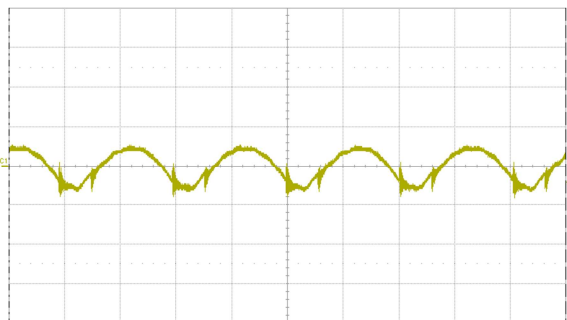

Fig. 14: Test setup for measuring input reflected ripple  $i_c$  and  $i_s$ .

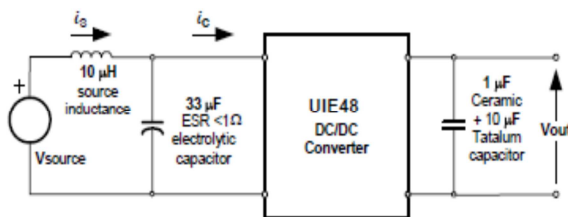

Fig. 15: Input reflected ripple current,  $i_c$  (1 A/div.), measured at input terminals at full rated load current and  $V_{in} = 48 \text{ V}$ . Refer to Fig. 14 for test setup. Time scale:  $2 \mu\text{s}/\text{div}$ .

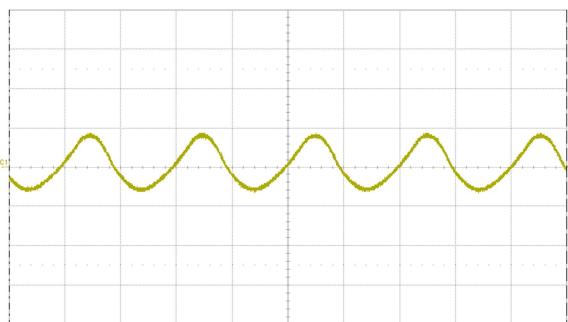

Fig. 16: Input reflected ripple current,  $i_s$  (50 mA/div.), measured through  $10 \mu\text{H}$  at the source at full rated load current and  $V_{in} = 48 \text{ V}$ . Refer to Fig. 14 for test setup. Time scale:  $2 \mu\text{s}/\text{div}$ .

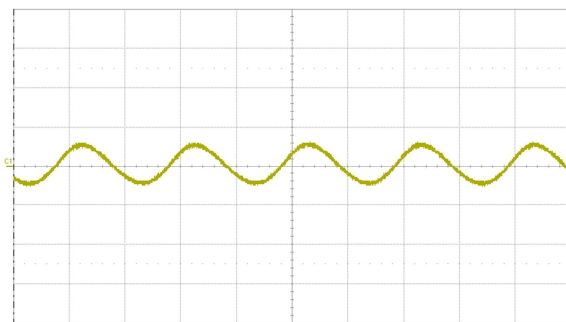

Fig. 17: Load current (top trace, 20 A/div, 100 ms/div.) into a  $10 \text{ m}\Omega$  short circuit during restart, at  $V_{in} = 48 \text{ V}$ . Bottom trace (20 A/div., 10 ms/div.) is an expansion of the on-time portion of the top trace

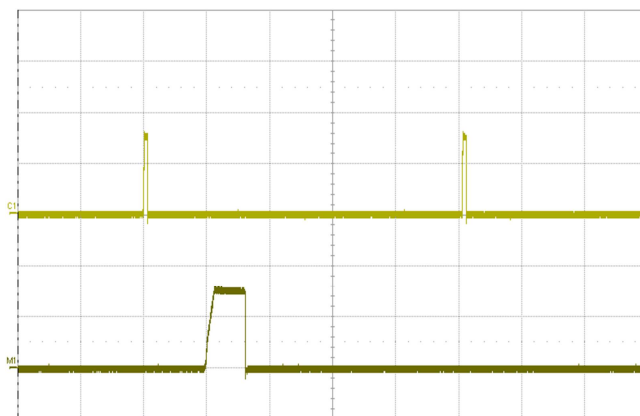
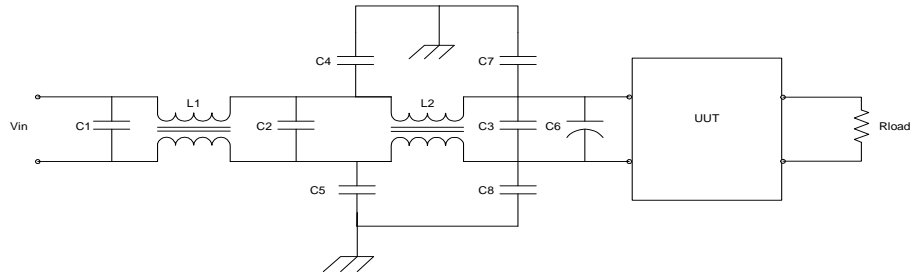

Fig. 18: Typical input EMI filter circuit to attenuate conducted emissions.



COMP. DES.	DESCRIPTION
C1, C2, C3	2uF, 100V ceramic cap
C6	100uF, 100V electrolytic cap
L1, L2	0.59mH, Pulse P0353NL
C4, C5	4700pF, ceramic cap
C7, C8	4700pF, ceramic cap

Fig. 19: Vin+ Peak Detector EMI waveform

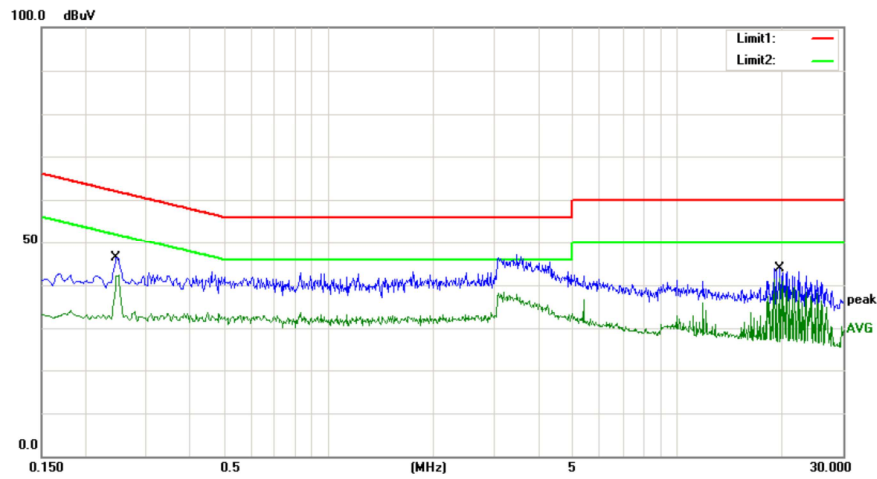
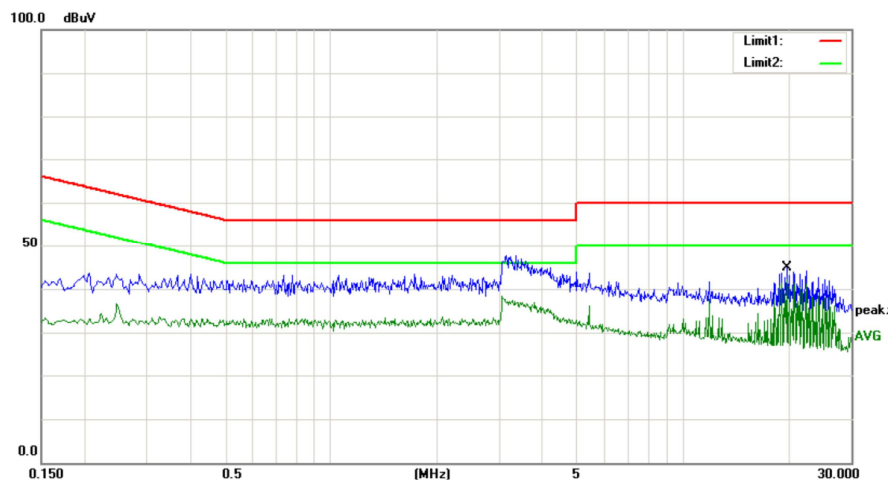
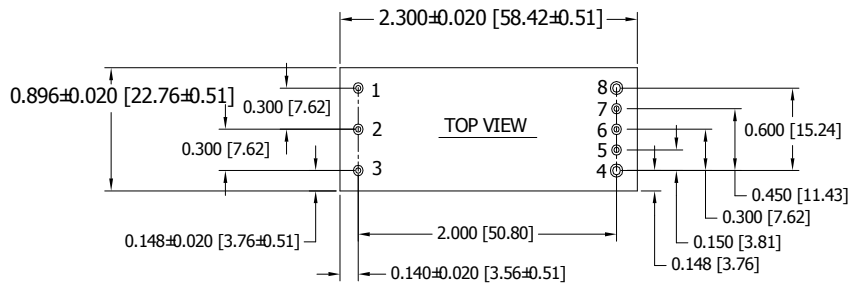

Fig. 20: Vin- Peak Detector EMI waveform



## 6 PHYSICAL INFORMATION

### 6.1 UIE48T PINOUT (THROUGH-HOLE)



PAD/PIN CONNECTIONS	
PAD/PIN #	FUNCTION
1	V <sub>IN</sub> (+)
2	ON/OFF
3	V <sub>IN</sub> (-)
4	V <sub>OUT</sub> (-)
5	V <sub>OUT</sub> (-) Sense
6	Trim
7	V <sub>OUT</sub> (+) Sense
8	V <sub>OUT</sub> (+)

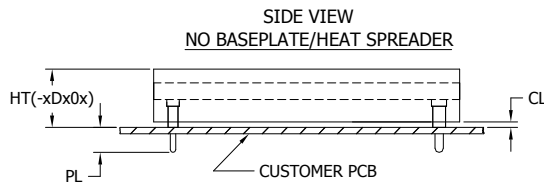

	HEIGHT [HT]	MIN CLEARANCE [CL]	SPECIAL FEATURES
D	0.440" [11.18] Max	0.028" [0.71]	0
	0.500" +/-0.020 [12.70 +/-0.51]	0.028" [0.71]	B

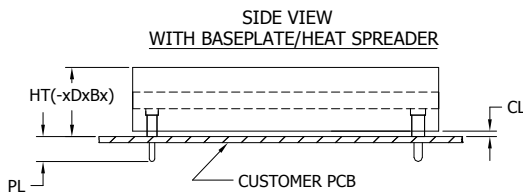

PIN OPTION	PIN LENGTH [PL]
	±0.005" [±0.13]
A	0.188" [4.78]
B	0.145" [3.68]

#### UIE48T Platform Notes

- All dimensions are in inches [mm]
- Pins 1-3 are  $\varnothing$  0.040" [1.02] with  $\varnothing$  0.076" [1.93] shoulder
- Pins 4 and 5 are  $\varnothing$  0.062" [1.57] with are  $\varnothing$  0.096" [2.44] shoulder
- Pin Material: Brass Alloy 360
- Pin Finish: Tin over Nickel

## 6.2 BASEPLATE / HEAT SPREADER INTERFACE INFORMATION

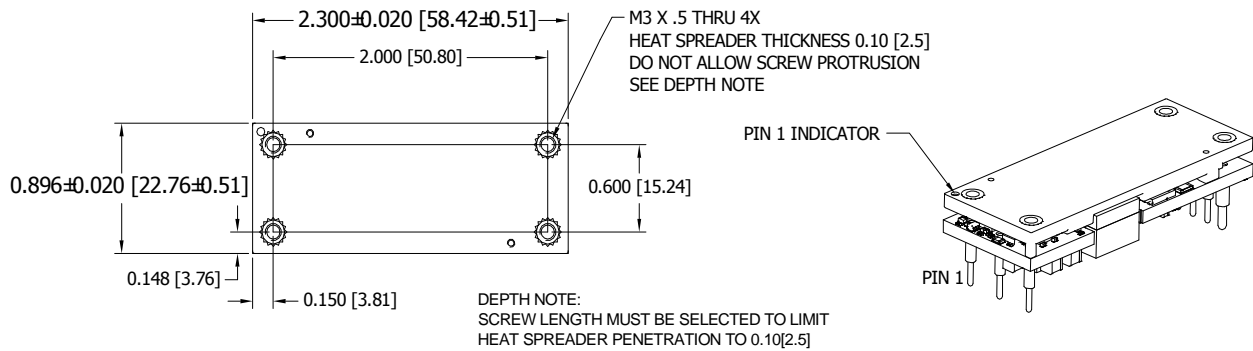

## 6.3 CONVERTER PART NUMBERING/ORDERING INFORMATION

PRODUCT SERIES	INPUT VOLTAGE	MOUNTING SCHEME	RATED CURRENT	OUTPUT VOLTAGE	ON/OFF LOGIC	MAXIMUM HEIGHT [HT]	PIN LENGTH [PL]	SPECIAL FEATURES	RoHS	
UIE	48	T	24	050	-	N	D	A	B	G
Eighth Brick Format	18-75 V	T ⇒ Through-hole	24 ⇒ 24 ADC	050 ⇒ 5V	N ⇒ Negative P ⇒ Positive	D ⇒ 0.440" for -xDx0x 0.520" for -xDxBx	Through hole A ⇒ 0.188" B ⇒ 0.145"	0 ⇒ Standard B ⇒ Baseplate option	G ⇒ RoHS compliant for all six substances	

The example above describes P/N UIE48T24050-NDABG: 18-75V input, through-hole, 24A@5V output, negative ON/OFF logic, maximum height of 0.52", 0.188" pin length, with baseplate / heat spreader, RoHS compliant for all 6 substances. Consult factory for availability of other options.

## 7 SOLDERING INFORMATION

### 7.1 THROUGH HOLE SOLDERING

Below table lists the temperature and duration for wave soldering

WAVE SOLDER PROCESS SPECIFICATION	PB-FREE:	SN/PB EUTECTIC
Maximum Preheat Temperature	130°C	110°C
Maximum Pot Temperature	265°C	255°C
Maximum Solder Dwell Time	7 Sec	6 Sec

### 7.2 LEAD FREE REFLOW SOLDERING

The unit is Paste In Hole (PIH) compatible. The profile below is provided as a guideline for Pb-free reflow only. There are many other factors which will affect the result of reflow soldering. Please check with your process engineer thoroughly.

Fig. 21: Lead Free solder reflow profile:

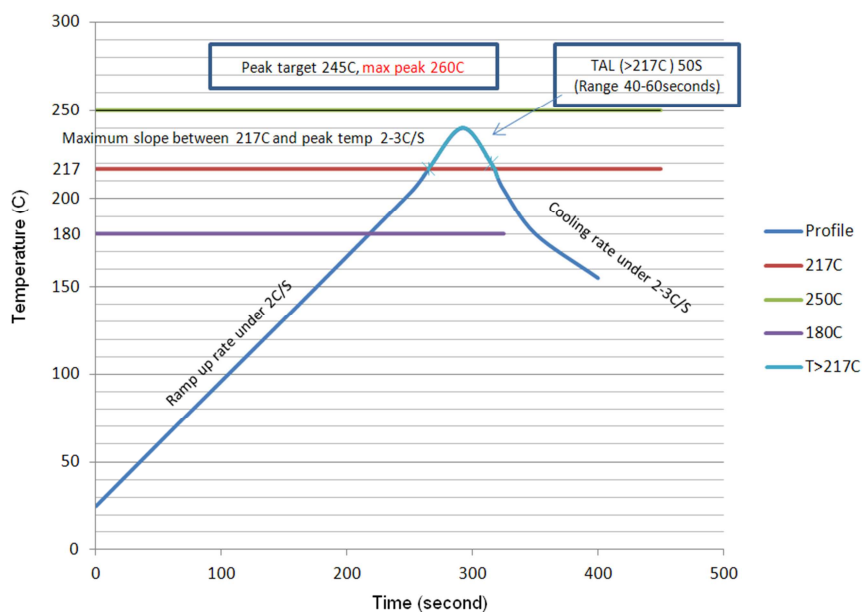

For PIH reflow process, the unit has a MSL rating of 3. The unit is packed using a Moisture Barrier Bag (MBB) with humidity Indicator Card (HIC) and drying desiccant included. Using products in Pb-free reflow soldering process required dry pack storage and handling. In case the products have been stored in an uncontrolled environment and no longer can be considered dry, the module must be baked according to IPC/JEDEC J-STD-033.

**NUCLEAR AND MEDICAL APPLICATIONS** - Power-One products are not designed, intended for use in, or authorized for use as critical components in life support systems, equipment used in hazardous environments, or nuclear control systems without the express written consent of the respective divisional president of Power-One, Inc.

**TECHNICAL REVISIONS** - The appearance of products, including safety agency certifications pictured on labels, may change depending on the date manufactured. Specifications are subject to change without notice.